

1:2.5

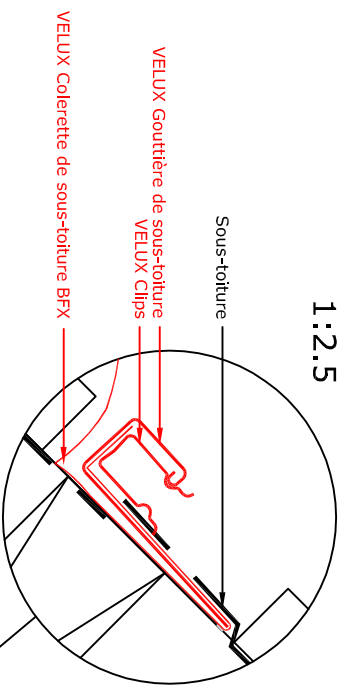

VELUX Gouttière de sous-toiture  
VELUX Clips

VELUX Colerette de sous-toiture BFX  
VELUX Gouttière de sous-toiture

VELUX Colerette de sous-toiture EDW

VELUX Partie supérieure du raccordement EDW

Coupe A-A  
1:5

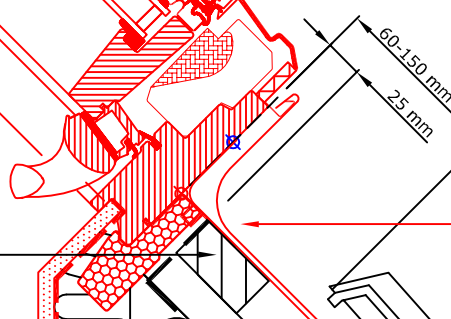

Latte de montage - 8mm

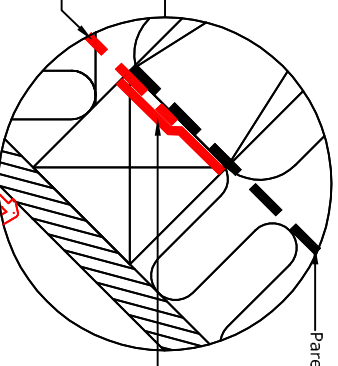

Joint collé avec le ruban adhésif du VELUX B BX

1:2.5

Coupe B-B  
1:5

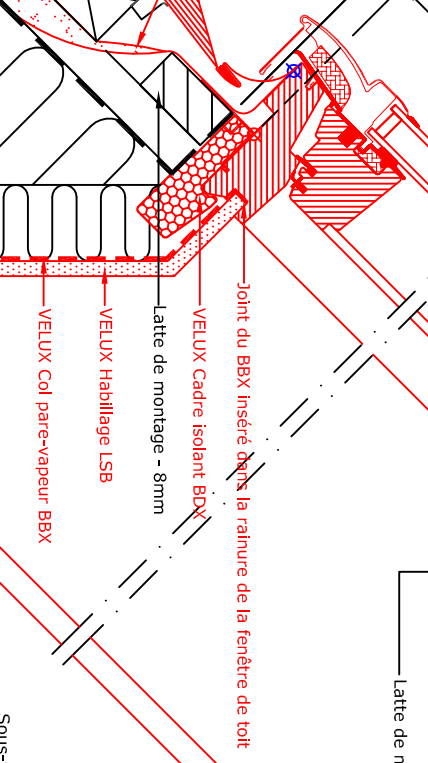

VELUX Joint en mousse





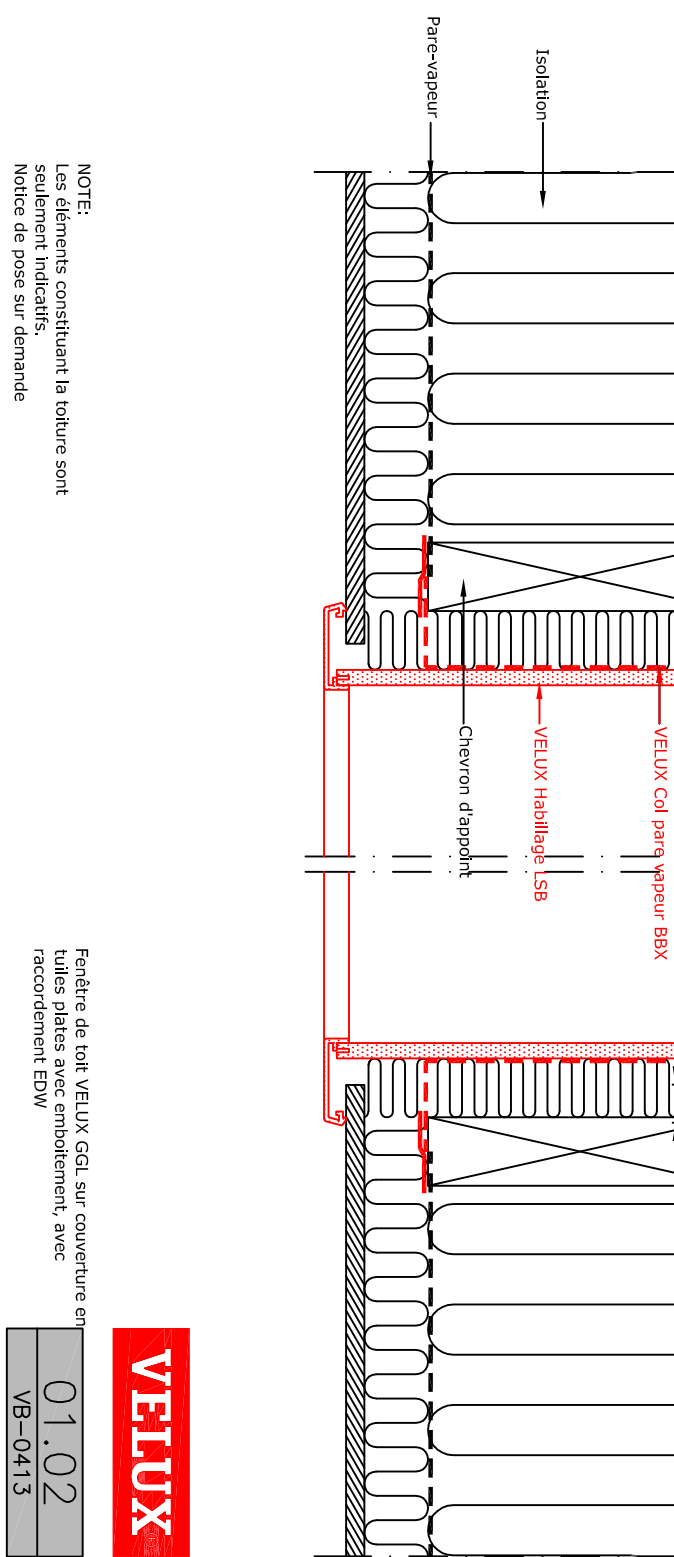

VELUX Colerette de sous-toiture

VELUX Cadre isolant BDX

30-60 mm

Découpe de 8mm de la latte à panne. Evite une remontée des tuiles.



-  GGL 15-40<sup>00</sup>
-  EDW 15-40<sup>00</sup>
-  BFX
-  BDX 2000
-  LS-B BX
-  Tuiles Plates

NOTE:  
Les éléments constituant la toiture sont  
seulement indicatifs.  
Notice de pose sur demande

Fenêtre de toit VELUX GGL sur couverture en  
tuiles plates avec emboîtement, avec  
raccordement EDW



01.02  
VB-0413